



Kampuchea Action to Promote Education (KAPE)

"Development with a Human Face"



Annual Report 2019

Released on 31st January 2020

Central Office: Provincial Teacher Training College (PTTC), National Road 7, Kampong Cham Province, Cambodia
Mailing Address: P.O Box 1621 Phnom Penh, Cambodia

042-941-481 / 042-941-918 kape@kapekh.org www.kapekh.org
www.facebook.com/kapeaction www.facebook.com/kapeaction
www.youtube.com/TheKapeCambodia
www.linkedin.com/company/kampuchea-action-for-primary-education

Notice: For more impacts of each project, please see our website. You could read more case studies of our project implementations at: http://www.kapekh.org/en/what-we-do/4/?pro_id=20

(Registered with Ministry of Interior since 1999.)

Greetings from the KAPE Board of Directors

On behalf of the KAPE Board, I would like to approve the Annual Agency Report of FY2019 that started in January and ended in December of this year. The report demonstrates both successful transitions, new accomplishments, and an expansion in funding resources. The latter has not been easy in today's difficult operating environment. This report is particularly unique because it occurs on the agency's 20th Anniversary and as KAPE starts its 3rd Decade of development. The Board would like to congratulate all KAPE staff on their successful efforts to help disadvantaged Cambodian children access educational services of high quality while maintaining excellent standards of governance, transparency, and efficiency in the use of funds.

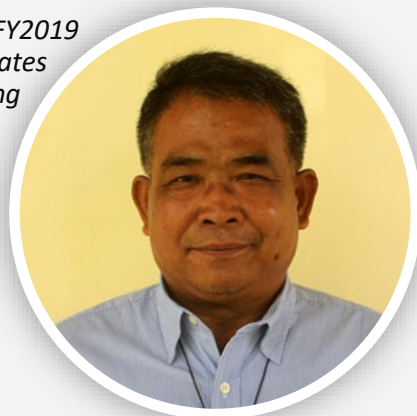

Mr. Heang Koy
KAPE Board Chairman

KAPE is a local non-profit NGO working primarily in the formal education sector in 14 provinces in Cambodia. KAPE implements projects at all levels of the education process with beneficiaries in primary schools, secondary schools and tertiary programs. Direct beneficiaries number well over 71,000 children and several hundred teachers, at over 165 schools.

KAPE Vision

Our vision is for children and youth to be able to make the best life choices possible that match their potential as a result of a good education.

Our Mission

To work with government, community and other stakeholders, to empower vulnerable children and youth to achieve their own right to a quality education through innovative approaches.

Our Core Values

- Empowerment
- Solidarity
- Compassion
- Respect
- Cooperation
- Innovation
- Transparency
- Truth

Table of Contents

Greetings from the KAPE Board of Directors.....	2
A Note from the KAPE Executive Director	3
Agency Overview for the Year	4
A Glance into the Future	5
Special News and International Events	6
TTO Import Export Co., LTD	11

Programs

New Generation School Initiative (NGSI).....	12
New Generation School (NGS)-Svay Rieng.....	14
Books for Cambodia (BfC) Project	16
Food For Education (FFE) Project	17
Inclusive Education Program (IEP).....	18
Happy Cambodian Children (HCC) Project.....	23
Easy2Learn (E2L) Project	24
Quality Learning Environment Expansion (QLE).....	26
Total Reading Approach for Children (TRAC III)	27
Reinforcing Education Access with Community Help (REACH)	28
Life Skills Learning for Adolescent Girl (LSLAG) Project.....	30
Teaching Improved Gender Equality and Responsiveness (TIGER)	31
KAPE Financial Highlights 2019.....	32
KAPE Management Team FY 2019	33
KAPE Organizational Chart 2019	34

A Note from the KAPE Executive Director

It is with great pleasure that KAPE shares this Annual Report with its partners because it marks the agency's 20th Anniversary and the start of a new decade of service to Cambodia's children and youth. KAPE was established in October 1999 as an agency with a very local focus. Today, KAPE has grown into the largest Local NGO working in the formal education sector in Cambodia. To reflect our broader scope, KAPE achieved another milestone this year, which was to change our name from Kampuchean Action for Primary Education to Kampuchea Action to Promote Education. The Ministry of Interior recently approved our new registration in 2019 but we have maintained the same acronym of KAPE to help preserve our well-known branding.



KAPE starts its 3rd decade of programming in a position of great strength with 20 projects in operation and historically high revenue levels. This is the most projects that KAPE has ever implemented at the same time. Some of the agency's new projects continue to be short-term but focus on activities that will have major synergies with other projects. These short-term projects include our e-Counseling programming (Trey Visay Project) and the development of Khmer Readability Software (Khmer Readability Program). The former is highly relevant to our youth programming while the latter will be invaluable to our many reading programs.

Some of KAPE's new programs that came online in 2019 are quite ground breaking. This includes the establishment of the New Generation Pedagogical Research Center at the National Institute of Education. This new Center will provide a Master's Degree in Mentoring to selected candidates, which will enable MoEYS to establish school-based mentoring systems in all of its New Generation Schools and beyond. MoEYS has asked KAPE to help manage this center, which is a tremendous honor for the agency and speaks to the high degree of trust that KAPE has built with the government as part of its New Generation School programming. The establishment of this center means that KAPE now has programming that ranges from Early Childhood Care and Development to Graduate Degree Education.

Another major new program that started at the end of 2019 includes the Strengthening Education & Employability in Kampuchea Project (SEEK). SEEK is funded by the European Union and represents the first time that KAPE has ever received direct funding from a bi- or multi-lateral donor. KAPE had always believed that USAID would be the first bilateral donor to provide direct funding to KAPE but KAPE's high convergence with EU development priorities (e.g., youth, employability, and strengthening civil society) has changed the course of events. While KAPE continues to place a strong strategic focus on its historical shift in funding away from bi-lateral funding, this alliance with the EU will help KAPE to improve its networking and profile. Nevertheless, the majority of KAPE's funding continues to derive mainly from private foundations and the Cambodian government.

Besides the EU, KAPE also welcomed several other new donors this year including Lotus Outreach and GAP and continued its strong relationship with its private foundation partners including The Asia Foundation, the Franks Family Foundation, the Phoenix Foundation, the Kinchan Foundation, the Oaktree Foundation, Child Fund Cambodia, WeWorld-GVC, VVOB, and Save the Children.

KAPE would like to thank once again all of its partners and stakeholders for their support during the past year and we look forward to working together to improve the education system for Cambodian children and youth in the coming new decade.



Agency Overview for the Year

school system. The use of software in education aligns with KAPE's strategic planning to generate efficiencies in educational operation by intensive utilization of technology.

KAPE's overall financial situation continued to improve during the year with annual revenues jumping from **\$3.56** million in FY2018 to **\$3.76** million in FY2019 or an increase of **6%**. At the end of the year, KAPE counted 17 donors and partners including new or returning donors such as EU, Lotus Outreach, and GAP. Nevertheless, it is important to note that about **48.63%** of agency revenues are now coming from the Ministry of Education, Youth, and Sport, making the Royal Cambodian Government KAPE's



largest donor. Another **15.96%** is coming from private foundations while the remainder is bilateral or multilateral. Fund utilization rates during the year stood at **90%**, which is quite high given the size of KAPE's portfolio. As in past years, **61%** of agency resources were spent on beneficiary support including educational services, school materials and equipment, school grants, and research in FY2019.

A Glance into the Future ...

As a number of project cycles were scheduled to end in 2019, KAPE has continued its heavy investment into program development that corresponds to the agency's 5-year Strategic Planning. As noted earlier, this led to a strong focus of agency efforts on youth issues, early grade literacy, technology in education and most importantly, charter school development. In all, 15 project designs were submitted for donor review and approval. Of these, all were successful, except one which is still pending (see Qatar Foundation). Nine of these approvals were for project extensions while the remainder was for new projects (SEEK, USE-SDP, E2L/ Prey Veng, GEI, and Ponlok Chamnaes) or an increase in funding to an existing project (LSLAG). As a result of program development efforts during the year, KAPE expects to field 20 projects in the next fiscal year.

Program Development Summary for 2019

Program	Partners	Donor	Status	Duration
1). Upper Secondary Education – Sector Development Project	VSO	Asian Development Bank-MoEYS	Successful	3 Years
2). New Generation Schools/Svay Rieng (Extension)	--	Child Fund	Successful	3 Years
3). Easy2Learn/Prey Veng	--	Child Fund	Successful	3 Years
4). Strengthening Education & Employability	WeWorld-GVC Buddhism for Social Development Action Youth Council of Cambodia	EU	Successful	3 Years
5). Life Skills Learning for Adolescent Girls (Increase in Funding)	--	Gap, Inc.	Successful	1 Year
6). Happy Cambodian Children (Extension)	Krousar Yoeung	Kinchan Stiftung	Successful	1 Year
7). Girls' Education Initiative	--	Lotus Outreach	Successful	3 Years
8). New Generation Schools Initiative/Secondary School Level (5 th Extension)	Franks Family Foundation World Education	MoEYS	Successful	1 Year
9). New Generation Schools Initiative/Primary School Level (3 rd Extension)	Franks Family Foundation	MoEYS	Successful	1 Year
10). New Generation Pedagogical Research Center (Extension)	Child Fund Franks Family Foundation	MoEYS	Successful	1 Year
11). Kampuchean Young Leaders' Association (Extension)	--	Oaktree Foundation	Successful	1 Year
12). TRAC III (Plus) (Extension)	--	Phoenix Foundation	Successful	2 Years
13). Educate a Child (Extension)	Aide et Action	Qatar Foundation	Pending	3 Years
14). Books for Cambodia (Extension)	--	The Asia Foundation	Successful	1 Year
15). Ponlok Chamnaes	--	The Asia Foundation	Successful	1 Year

Special News and International Events

"Development through networking and outreach."

KAPE REPRESENTATIVE MEETS FORMER FIRST LADY MICHELLE OBAMA



Ms. Hem Mary, KAPE's IEP Coordinator (second from right) sits with Michelle Obama at the Inaugural Leaders of the Asia-Pacific Conference in Kuala Lumpur, Malaysia in December 2019.

Between 10 to 14 December 2019, Ms. Hem Mary, KAPE's Inclusive Education Program Coordinator, was invited to join 200 other young leaders from across the Asia-Pacific Region in a meeting led by Michelle Obama, former First Lady and wife of US President Barack Obama. Michelle Obama spoke at the Obama Foundation's inaugural "Leaders: Asia-Pacific" gathering in Kuala Lumpur, Malaysia as part of an effort to kick off youth mobilization activities led by the Foundation. The meeting focused on shared values and ethical leadership and sought to empower young Asian leaders to tackle the unique challenges they face in their communities. This is the second time that a KAPE representative had the opportunity to have a close-in encounter with Michelle Obama. Several years earlier, the KAPE Executive Director also met with the First Lady in Siem Reap in 2012. KAPE was greatly honored to be chosen once again to send a representative to this event organized by the Obama Foundation.

OPENING OF THE NEW GENERATION PEDAGOGICAL RESEARCH CENTER



Minister of Education, Youth, & Sport officially opens the Pedagogical Research Center and meets with degree candidates

In 2018, MoEYS asked KAPE to assist in setting up a graduate center at the National Institute of Education (NIE) that could train teacher mentors to sustain teacher development activities in New Generation Schools. These efforts came to fruition in 2019 with the official opening of a new Center building at NIE. H.E. Hang Chuon Naron, Minister of Education, Youth and Sport presided over the official opening ceremony of the NGPRC, on 21 November 2019 in Phnom Penh. The inauguration was attended by numerous officials from MoEYS, ChildFund, and other organizations as well as 25 Master Degree Candidates who were recently admitted to the Center. The Center provides a 21st Century learning environment by ensuring a closely knit community of instructors and students, modern facilities, and new software designed to promote teacher mentoring.

KAPE SENDS REPRESENTATIVES TO ATTEND THE REGIONAL BRITISH EDUCATION & TRAINING TECHNOLOGY TRADE FAIR IN MALAYSIA

Senior advisers from KAPE and its social enterprise partner, Thonthean Obrom or TTO, attended the annual regional trade fair sponsored by the British Education & Training Technology Forum (BETT) in Kuala Lumpur, Malaysia on 12-13 March 2019. This is the fourth time that KAPE has attended this event as part of its efforts to keep abreast of the latest developments in educational software. KAPE's attendance of these events has already greatly expanded the software portfolio used in agency-supported schools such as the introduction of Literatu (electronic formative evaluation), Twig (STEM software), and most recently Observic (teacher mentoring software). Through close cooperation with developers, KAPE has been able to contextualize these programs to the Cambodian situation. The agency's efforts in this respect have greatly helped Cambodian schools to bring their educational services into the 21st Century. KAPE's most recent participation in this event included Mr. Ul Run (National Adviser), Mr. Chhorn Chhayyuth (M&E and ICT Coordinator), Mr. Mai Sarit (REACH Program Manager), and Mr. Sum Vannak (TTO Managing Director).



Special News and International Events

"Development through networking and outreach."

PARLIAMENTARY MPs VISIT A NEW GENERATION SCHOOL

KAPE and Child Fund Cambodia have been working closely to replicate New Generation School reforms in rural areas of Cambodia such as Svay Rieng Province. The success of these efforts led to a high profile visit from the Royal Cambodian Government. Members of Committee 7 from the National Parliament visited Kok Pring Jr. HS and Svay Prahut PS in Svay Rieng Province on 8 August. Both schools are New Generation Schools that are part of the educational reforms initiated by MoEYS. The Parliamentary



H.E. Hun Many, Chairperson of Committee 7 for Education, Youth, Sport, Religious Affairs, Culture and Tourism pays a visit to students in a classroom at Kok Pring New Generation School in Svay Rieng Province.

Delegation was led by H.E. Hun Many who is also the Chairman of the Committee. Parliament expressed its strong support for these reforms and were very much impressed by what they saw including project work activities, ICT in education techniques, and 21st Century facilities. The visiting Parliamentarians were realists in recognizing the need for reforms like NGS but also gave sound advice that the reforms should proceed cautiously because many Cambodian educators and members of the public do not yet fully understand the reforms because they are so new to Cambodia. Nevertheless, the visit was a great promotion for NGS reforms and a reminder that these reforms are here to stay.

ATTENDANCE OF THE UNLEASH PROGRAM

This year, Mr. Chhorn Chhayyuth, a KAPE Senior Management Team member, was selected from a pool of over 8,000 international top talent applicants to become a global talent and representative of Cambodia to join the #UNLEASH2019 Program in Shenzhen, China. This event took place on November 6th -13th, 2019. Chhayyuth had the opportunity to work with over 1,000 other participants from 152 countries to develop new innovative solutions to achieve The Sustainable Development Goals (SDGs). During the workshop, Chhayyuth worked with his team on developing an Artificial Intelligence Chatbot that would help support mental health education for young girls in Nigeria.



Group Picture of Mr. Chhayyuth (second from Right) and his global talent group members who are working on SDG4 on the theme of ICT in Education.

NEW DEBUT FOR UPDATED VERSION OF TREY VISAY

Trey Visay (or 'Compass' in English) is an e-career counseling mobile application that allows students to do self-assessment and gather information on educational institutions and career options to prepare them for the future. The app was recently updated by KAPE and its partner InSTEDD for a new debut in February 2019. The app helps Cambodian schools to deal with the absence of Guidance Counselors by using a technological solution to help Cambodian youth make informed decisions about their futures. Trey Visay is now available to download both on App Store and Google Play Store. Please access the link below to download the latest version of Trey Visay.

App Store: <https://itunes.apple.com/kh/app/trey-visay/id1445506569?mt=8>

Google Play Store: <https://play.google.com/store/apps/details?id=com.treyvisay>

"Development through networking and outreach."

CAMBODIAN CHARTER SCHOOLS: ACHIEVING AN INTERNATIONAL PROFILE FOR KAPE WORK ON NEW GENERATION SCHOOLS

New Generation School Reforms continue to be one of KAPE's most important breakthroughs in promoting a higher standard of education in Cambodia's public schools. Although some conservative teachers opposed to educational reforms have been pushing back against New Generation Schools, the model continues to excite educators globally. On 1 February 2019, a presentation was made on New Generation School successes at the 'Global Education Forum' in Boston MA that was hosted by the Harvard Graduate School of Education. Another presentation on NGS was made at the International Comparative and International Education Society Conference in San Francisco in April 2019. In addition, well-known Harvard professor Fernando Reimers will be including a chapter on New Generation School reforms in his upcoming book and another publication called 'Education in Cambodia: From Year Zero to International Standards' (to be published by Springer Publishers) will also include a chapter on New Generation Schools as well. In other news, the Lao PDR is planning on replicating the New Generation model in Laos with support from the Franks Family Foundation. Finally, the Ministry and KAPE produced a tailor-made infomercial on New Generation Schools to educate the Cambodian public about the goals and objectives of NGS Reforms to further improve acceptance and understanding of the model (cf. <https://youtu.be/QXfTAR1Y6FU>). The creation of the Infomercial was jointly funded by MoEYS and the Franks Family Foundation. With all of this recognition, MoEYS is once again to be congratulated for promoting an exciting new educational reform.



GLOBAL EDUCATION CONFERENCE
FEBRUARY 1, 2019
9AM - 5PM • GUTMAN CONFERENCE CENTER
HARVARD GRADUATE SCHOOL OF EDUCATION

LEARN REFORMS, CHALLENGES, AND TRENDS IN IMPROVING GLOBAL EDUCATION AS DISCUSSED BY LEADERS IN INTERNATIONAL DEVELOPMENT:

- Elisa Bonilla, Visiting Scholar, David Rockefeller Center for Latin American Studies and former National Director of Curriculum, Ministry of Education, MEXICO
- Jaime Soavredra, Education Lead, THE WORLD BANK
- Luis Garcia de Brigard, Founder, Envoyos and Former Vice-Minister of Education, COLOMBIA
- Farzeel Khan, Visiting Practitioner, HGSE and Programme Specialist for Education, UNESCO
- Charito Kruvant, Founder and Board Chair, CREATIVE ASSOCIATES INTERNATIONAL
- Michael Sinclair, Director, HARVARD MINISTERIAL PROGRAM

PUBLICATION OF KAPE RESEARCH IN JOURNAL OF MODERN EDUCATION REVIEW

Between 2013 and 2017, KAPE received funding from Save the Children and NORAD to investigate the impact of holistic approaches to education on educational quality. This investigation was formulated as a formal research study that was recently published as a peer-reviewed scholarly article in the Journal of Modern Education Review. The research article was entitled, The Impact of Holistic Programs on Quality and Learning Outcomes in Cambodia cf. http://kapekh.org/files/report_file/105-en.pdf. The paper demonstrated that holistic programming supported by KAPE and Save the Children really made a difference in reading skills, and that although it was not possible to prove a clear relationship between the holistic framework developed by Save the Children, known as Quality Learning Environments (QLE), and student learning outcomes, three main improvements lead to better student learning outcomes in the framework of supported programming, "namely community-based monitoring, positive discipline and enriched teaching methods. The research paper was authored by four KAPE staff including Dr. Steven Prigent, Mr. Hang Pisseth, Mr. Daro Khorn, and Mr. Kaongyou Yuth.

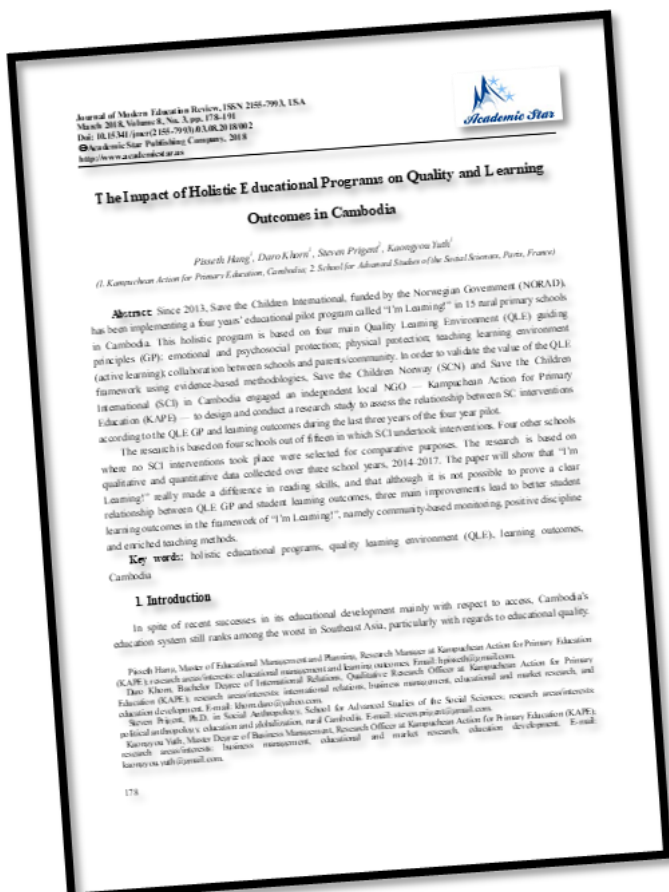

Special News and International Events

"Development through networking and outreach."

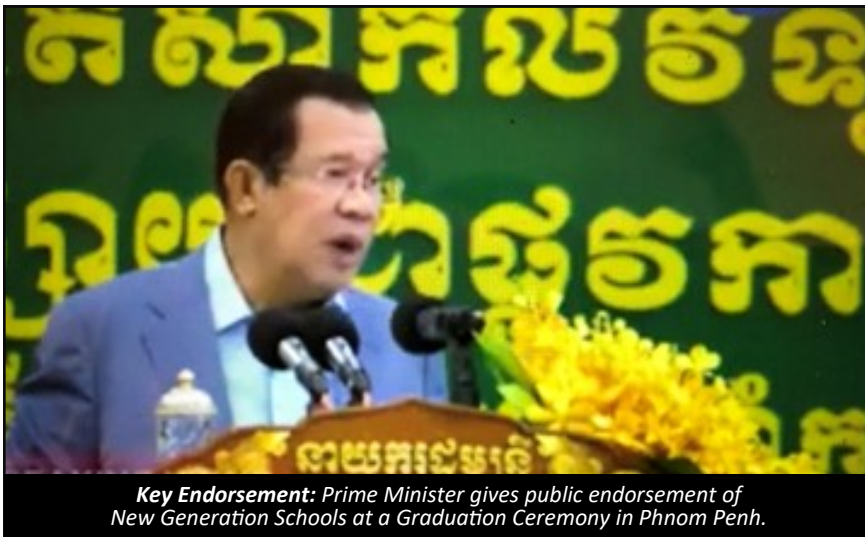

Key Endorsement: Prime Minister gives public endorsement of New Generation Schools at a Graduation Ceremony in Phnom Penh.

Prime Minister Hun Sen Gives Endorsement of New Generation Schools

At a graduation ceremony at Beltei International Academy in Phnom Penh, Samdech Hun Sen gave a strong recommendation to the private school sector to consider the successes and innovative programming that has been achieved by the New Generation School system. This was a dramatic endorsement of everything that has been achieved by New Generation Schools and a vindication for the far-sighted vision of the Minister of Education, Youth and Sport.

KAPE GOES ON THAI TV

Over the years, KAPE has made annual visits to premiere educational institutions in Thailand to learn from international experience in the region to better help Cambodian educators improve the education system here in the Kingdom. One of the schools most frequently visited has been Lamplimat Pathana Jr. HS in Buriram Province, Thailand. This school is famous in Thailand for its experimental education model in a rural area that has extremely high achievement test results on national examinations but yet has no entrance requirements, classroom tests, or external discipline. The school internalizes disciplinary control by only admitting children at the pre-school level so that they learn how to control their behavior from an early age, necessitating few or no external disciplinary provisions. Thus, 'children learn without fear,' which is a revolutionary concept for many Cambodian educators. KAPE has been bringing about 80 Cambodian educators to this school each year, travelling overland by bus to economize on costs. Over 350 Cambodian teachers and school managers have now had this international experience, leading to a special television expose on Thai TV about this collaboration between Cambodian and Thai educators. A Thai PBS show called, "Chab Ta" or Eye-Catchers aired this expose in 2019. Please watch on the link provided below.

Cambodian educators visit Lamplimat School in Thailand (above); Thai PBS airs an expose on KAPE-led collaboration with Thai educators (below).

<https://drive.google.com/file/d/1Uz9DrDJg1VYdg2iGkQf7IRc7gpLN5JOW/view?fbclid=IwAR163iyTvJ4j3K1Ih4mwDU04CmsfH7IqIm8WweL591APFmmtfdtJbTmiiA>





TTO Import Export CO.,Ltd.

"Effective and Affordable Teaching Aids!"

TTO Highlights

About Us

TTO is a local company promoting access to learning tools in and outside the classroom.

Product

- Teaching aids:
- Math 24 items
 - Literacy 32 items
 - Science 2 items
 - Assessment file 3

Certified

Publishing products approved by MoEYS.



Marketing, National Book Fair 2019 and Sales Work

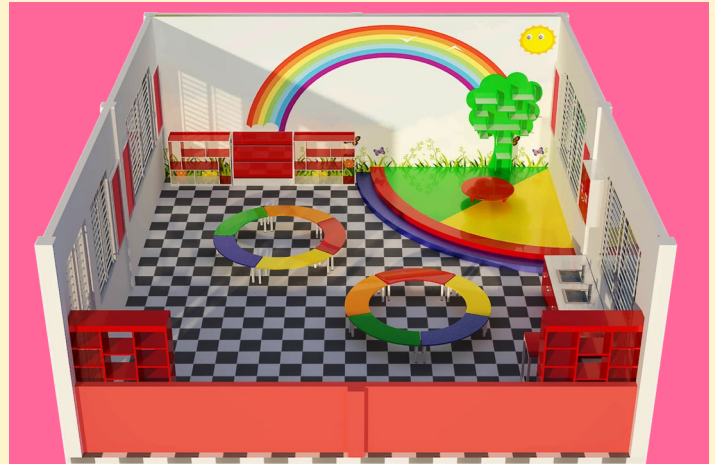

New Architecture Designs



Orientation Training on Teaching and Learning Aids



Sales and Product Delivery Work



◀ **Social Engagement:** TTO cooperated with its partner-NGO to help school develop the quality of learning environment.

For more detailed information, please see our website: www.tts-kape.org and remember to "LIKE" us on Facebook: www.facebook.com/ttskape.

New Generation School Initiative (NGSI)

"Cambodia's First Charter Schools"

Project Profile

Donor	MoEYS; Franks Family Foundation
Direct Beneficiaries	3,450 Students (Secondary) 1,635 Students (Primary) 5,085 Students (Total)
Budget Received in FY2019	\$1.6 million
Unit Cost per Beneficiary	\$314
Provinces Covered	4 (Phnom Penh, Kg Cham, Kg Speu, Kandal)
Districts Covered	6
Target Secondary Schools	5
Target Primary Schools	3
Start Date	October 2015
End Date	Open-ended

Project Update

The New Generation School Program completed its fourth year of funding support by MoEYS with KAPE playing the role of implementer. The number of supported New Generation Schools stabilized at 10 this year (with 8 supported by MoEYS/FFF and 2 supported by Child Fund). Some supported schools continued to expand the number of grade levels covered by NGS investment as they incrementally move towards 'whole' school coverage. This includes investments at Prek Leap, Prek Anchanh, Peam Chikong HS, as well as Akheamahasei Primary School. Demand for entry into New Generation Schools continued to explode and far exceeds the places available, demonstrating the high quality standards of these schools and acceptance by the general public.

Milestone Events

- **National Recognition:** The Royal Government of Cambodia has included New Generation Schools as an official development approach in its latest version of the national Rectangular Strategic Plan, providing national recognition of NGS Reforms at the highest level.
- **Increase in NGS Accredited Schools:** The number of fully accredited New Generation Schools increased from 2 to 4 with Sisovath HS and Hun Sen Kampong Cham HS now being joined by Kok Pring HS and the Demonstration School of Kampong Cham.
- **Spectacular National Exam Results:** Student cohorts from Sisovath HS and Hun Sen Kampong Cham HS achieved results that far exceeded the national average (68%) with a 94% pass rate at Sisovath HS and an 84% pass rate at Hun Sen Kampong Cham HS.
- **International Awards:** NGS schools received 424 Gold, Silver, & Bronze Medals during the year.
- **Extension of NGS Programming to the National Institute of Education:** MoEYS asked KAPE to establish a Master's Degree to train NGS Mentors at NIE. A new center was opened at NIE in September 2019.

Program Rationale

New Generation Schools refer to an educational reform inaugurated by the MoEYS in 2015 to create 'autonomous' public schools with a mandate to innovate and improve educational quality. Access to high investment funds is contingent on high standards of governance and professionalism. This new development track seeks to move public schools to the next level so that they can achieve '**maximal**' standards of education, especially in the STEM subjects. Under the new policy defining New Generation Schools, MoEYS has made a major commitment to make intensive investments in such schools under conditions that ensure high standards of good governance. With its system of strict accreditation requirements linked to on-going investment, the new policy incentivizes schools to adhere to high standards of education. New Generation Schools follow precedents in other countries where some public schools receive greater autonomy from the state to stimulate educational innovation. This speaks especially to the *Charter School Movement* in the United States and other countries. The MoEYS has a goal of establishing at least 50 New Generation Schools over the next 10 years.

Key Activities

- Expansion of NGS Reforms to the higher education sector by establishing an NGS facility at the National Institute of Education (see below).
- Developments of new training manuals in 21st Century Libraries & Student Assessment.
- Accreditation of 4 New Generation Schools (Sisovath HS, Hun Sen Kampong Cham HS, Kok Pring HS, and Demonstration School).
- Completion of 36 new facilities including NGS classrooms, science labs, 21st Century Libraries, Student Clinics, Youth Ctrs, and auditoriums.



New Generation Pedagogical Research Center Opens at National Institute of Education: At the request of MoEYS, KAPE built, furnished, and staffed a modern graduate education facility at NIE that will provide a Master's Degree in Mentoring to facilitate both the sustainability and expansion of NGS Reforms. The center has modern seminar and meeting rooms, is fully wired, and employs 21st Century teaching methods with class sizes limited to 15 students or less. ↓

↑ Modern Graduate Education facilities at the National Pedagogical Research Center include airy modern designs and colorful seminar rooms.



Snapshot



← **Applications of New Practices to Cambodian New Generation Schools:** Children at the Demonstration School in Kampong Cham meditate before starting their studies following a study trip to Thailand by teachers who are now replicating the practice in Cambodia.



← **Massive Public Demand for NGS Entry:** Parents fill the auditorium at Sisovath HS to overflowing, hoping to get their children into the school. Over 1,200 students applied for only 200 available seats in 2019.



← **21st Century Library Establishment:** The NGS Program completed a new modern library at Peam Chikong High School.



↑ **Promoting Student Research:** Students at Prek Leap HS use the research stations in their new library to complete a special group project. Individualized student research is a major element of the NGS Educational Program.

↑ **New Manual on 21st Century Library Development:** The project developed a standardized manual to assist other projects to replicate the modernistic designs and management that are used in New Generation School libraries. →

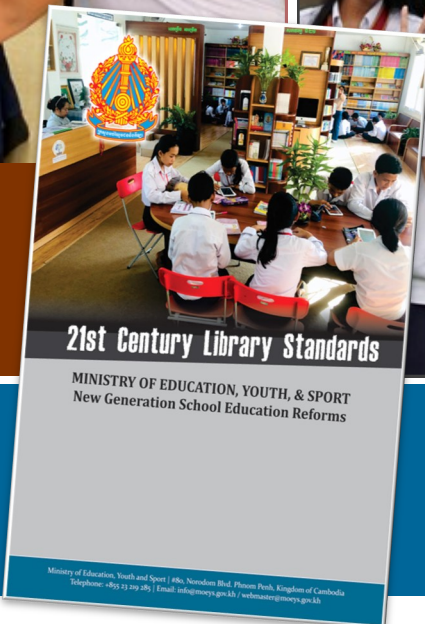

Features

SCHOOLS FOR THE NEXT GENERATION . . .

Youth Empowerment Services

The principle of Youth Empowerment, as mandated by the MoEYS' National Youth Development Policy, plays a key role in the New Generation School model. Youth Empowerment principles are manifested by student choice in the subject themes they wish to study and voluntary club membership. Counseling services provided to youth help to ensure that youth decisions are well informed.

Special Student Services

New Generation Schools provide new student services not found in normal public schools including:

- 21st Century e-Library – Counseling Services – Subject Clubs – Life Skills Education – Electronic Assessment – Software-based Learning



↑ **21st Century Auditorium for a 21st Century School:** Students at Hun Sen Kampong Cham HS enjoy a meeting in their new auditorium with its new modern design. The auditorium is fully wired and has built-in audio-visual facilities and a nice lobby (above). An outside view of the new auditorium at Hun Sen Kampong HS, which provides a dramatic contrast to more traditional architecture used in the public schools (right); →



↑ **Making Cambodia Proud:** Students from Sisovath HS show some of the medals that they won at international competitions during the school year. New Generation Schools provide amazing advocacy for their students that enables them to access many national and international competitions, which incentivizes learning.

New Generation School (NGS)-Svay Rieng

"Cambodia's First Charter Schools"

Project Profile

Donor	Child Fund Cambodia
Direct Beneficiaries	757 Students
Budget Received in FY2019	\$146,526
Unit Cost per Beneficiary	\$194
Provinces Covered	Svay Rieng
Districts Covered	Svay Chhrum
Target Secondary Schools	1
Target Primary Schools	1
Start Date	July, 2018
End Date	August, 2021

Key Activities

New Program Cycle: KAPE completed a three-year cycle of investment at Kok Pring Jr. HS and Svay Prahut PS in 2017. A new investment cycle that was also funded by Child Fund started in 2018 with a focus on achieving accreditation for the secondary school.

Accreditation as a New Generation School: The accreditation of Kok Pring Jr. HS was achieved in 2019 and a certificate of accreditation has been issued by MoEYS. This achievement marks a major milestone for the program and opens the pathway to eventual government funding, as the NGS Policy requires MoEYS support for any school accredited by the National Oversight Board. Thus, KAPE and Child Fund should be able to phase out their support in the near future, shifting support instead to government and the local community.

Upgrading Kok Pring Jr. HS into a Senior High School: The high standards at Kok Pring Jr. HS have led to increased interest in upgrading the school to be an upper secondary education facility. This was agreed by the Provincial Office of Education and the MoEYS in Phnom Penh, thereby transforming the school into a high school starting in the 2018-19 academic year. Funds from the Provincial Governor's Office have been allocated to build a new building to accommodate upper secondary school classes.

Planning to Upgrade Svay Prahut PS: At the end of the first development cycle in 2017, it was recommended by an external evaluator to postpone future investment at the adjacent primary school in the same compound until Kok Pring HS achieved accreditation. Now that this has been achieved, Child Fund and KAPE will consider a new investment plan to also upgrade Svay Prahut PS.

Visit from Parliament: A delegation of Parliamentarians led by H.E. Hun Many visited Kok Pring HS on 8 August 2019, further giving a high profile to the school.

Program Rationale

The New Generation School Program in Svay Rieng is similar in its configuration to the national NGS Program funded directly by MoEYS and implemented by KAPE. Key features of the program in Svay Rieng include the establishment of autonomous public schools that are required to achieve high educational standards as a condition of high investment. These standards are subject to an accreditation process to validate that standards mandated in the policy framework have been achieved. Thus, governance, accountability, and high levels of professionalism are the central elements of the program. The NGS Pilot in Svay Rieng is somewhat different from the national program in that it involved the selection of a school in a very rural area to test the proposition that NGS replication is possible in a non-urban setting. With the official accreditation of the school by the National NGS Oversight Board this year, there is now confidence that the model can be replicated in rural areas. Nevertheless, the pilot found that it takes longer than 3 years of investment to reach required standards (as stated in the policy) and this should be kept in mind in cases of future replication.

Snapshot



Bio-garden income in NGS-SVR

Students' exhibition day



Exposure visit to NGS Prekleap HS

ICT lab activities



Teacher's Day was celebrated to share gratitude for teachers' efforts in their teaching jobs.

A reading competition event was hosted at Kok Pring High School reflects students' high reading capacity as a result of recent investments. This is now an annual event that students look forward to each year.



Parents' Night Exhibition

Each year, New Generation Schools organize an exhibition by students to demonstrate to their parents what they are learning and how. It is for this reason that the exhibitions are known as a Parents' Night Show. The exhibitions occur in the late afternoon and evening so that working parents can visit the school without having to take time off from work. Kok Pring HS received a small grant to pay for materials and projects that students create. This year, students working in their groups created 52 projects including a home made electrical generator.



Parents' night show: Students made several amazing projects including a generator to produce electricity.

Features



Hands-on science learning in a school lab

SCHOOLS FOR THE NEXT GENERATION ...

Successful Recruitment of New Teachers Has Raised Teacher Professional Standards Further

With the recruitment of 7 new teachers to work at Kok Pring HS, teaching standards continued to increase this year. Of the 28 teachers recruited to work at the school, 88% now have Bachelor's Degrees and 25% have NIE degrees (to teach a newly created class at the Grade 10 level). All teachers are highly technology literate and have made great strides in their ability to use ICT in the teaching and learning process at this New Generation School. Teachers were competitively recruited to work at the school and tend to be young and enthusiastic. The Professional Learning Community (PLC) is very dynamic and provides a professional setting for teachers to learn from one another and improve their practice. There are active discussions about using target methodologies such as Constructivism with the state curriculum.



H.E Hang Chhoun Naron, Minister of Education Youth and Sports visits Kok Pring New Generation School on a fact finding mission.



Formative testing of primary school students in Grade 3



Visit from the British Ambassador



PLC Meetings show teachers are very ICT literate

Books For Cambodia (BfC)

"Enriching children's lives with books and media."

Project Profile

Donor	The Asia Foundation & MoEYS
Direct Beneficiaries	118,256 (female 61,374)
In-kind Support Received in FY2019	364,038.96 USD
Unit Cost per Beneficiary	\$3.08
Provinces Covered	9 (including Phnom Penh)
Districts Covered	39
Target-government institutions and universities	6
Target-NGOs	1
Target Secondary Schools	124
Target Primary Schools	2
Other Institutions	0
Start Date	1 April 2014
End Date	31 Dec 2022

Project Update

The Books for Cambodia Program has completed its sixth year of operation and is currently preparing for a continuation of its book donations to 5 new provinces in 2020 such as Preah Sihanoukville, Koh Kong, Pursat, Kampong Chhnang, and Battambang. A renewed MoU with MoEYS has set the stage for expanded book donations that will eventually benefit all 25 provinces and municipalities in Cambodia. Over 200 secondary schools in new target provinces will be eligible to apply for book donations from the BfC Showroom next year. BfC is also preparing to identify a potential school to host an experimental Online Library that will be established in 2020.

Project Impact

Creating a Culture of Learning: BfC continues to provide technical support to librarians nationwide to facilitate students' access to books that match their interests. Librarians have been trained to organize reading groups for young children in their schools and to facilitate access to electronic books by using mobile learning devices supplied to libraries by other KAPE programs.

Library Enhancement: BfC has provided large amounts of reading books to many school libraries throughout the country. Since its inception, BfC has distributed 58,993 books and reading materials to 382 schools and public libraries throughout Cambodia.

Looking Ahead: During 2019, BfC made distributions to 9 provinces. Next year, BfC will add 5 new provinces to its distribution target. In addition, BfC will continue to organize Spelling Bees in more schools. In FY2019, BfC organized over 15 Spelling Bee events and will seek to increase this number in the future. Spelling Bees incentivize learning and reading English. The most recent MoU signed with MoEYS gives priority to lower secondary schools and will target five new provinces annually, with the intention of covering all 25 provinces within five years.

Enhanced Monitoring: BfC will also intensify its efforts to maximize the utilization of English books by more frequent school monitoring. BfC now uses social media platforms such as *Telegram* and *Facebook* to share and follow up reading activities. BfC will also conduct realtime surveys of book usage using *KoBoToolBox* & *Google Survey*.

Core Goals

BfC's new MoU with MoEYS prioritizes book donations to lower secondary schools, targeting 5 new provinces annually with the intention of covering all 25 provinces within five years. The project seeks to promote English reading at lower and upper secondary school levels. Next year, BfC will select an outstanding school from among 200 candidate schools where it will pilot an Open Access Library.

Key Activities

- Books for Cambodia continued to process book requests from schools and distributed 22,320 donated English books in 2019. These books are high quality publications donated by publishing companies in the United States.
- KAPE conducted regular monitoring and evaluation of book use by using social media platforms such as Telegram and Facebook.
- Program planners compiled a report of assessment findings with concrete recommendations to management to maximize book access.
- BfC administered real-time surveys in schools using KoBoToolBox and Google Survey to monitor access to donated books.
- BfC staff members incentivized reading activities by organizing Spelling Bees and outreach to parents to support reading activities at home.

Snapshot



KAPE Director (right) and The Asia Foundation Country Director (left) sign an MoU with the Minister of Education, Youth & Sport to continue expanding BfC programming.



Spelling BEE Competition: The students above are competing in one of the many Spelling Bees organized by BfC. These spelling events help to motivate students to read English books and improve their spelling skills.

Food For Education (FFE)

"Promoting Learning Environments for Growth"

Project Profile

Donor	US Department of Agriculture (USDA); World Food Program (WFP); World Education (WE)
Direct Beneficiaries	Teachers in Grades 1-3 in 503 schools
Budget Received in FY2019	\$129,984
Unit Cost per Beneficiary	N/A
Provinces Covered	Siem Reap and Kampong Thom
Districts Covered	18 districts (7 in Kampong Thom and 11 in Siem Reap)
Target Secondary Schools	N/A
Target Primary Schools	503 Schools (205 schools in Kampong Thom & 298 Schools in Siem Reap)
Start Date	November 2016
End Date	October 2019

Project Update

The Food for Education (FFE) Project came to an end this year after a 3-year project implementation cycle. FFE was jointly implemented by World Education (WE) and KAPE and focused on improving early grade literacy inputs to complement school breakfast programming, which is supported by USDA. KAPE was primarily responsible for teacher training and school monitoring. In its final year of operation, FFE supported technical inputs to 503 target primary schools. Teacher training and frequent monitoring have been core elements of FFE programming. The project has sought to align its teacher training activities with the evolving Teacher Policy Action Plan (TPAP). This has entailed providing credits for completion of training workshops and aligning EGRA tools with those recently developed by the Primary Education Department. Since start-up, the project team has developed 5 training modules on how to teach reading, which were used to train 2,575 teachers in Grades 1 to 3 during the year. The team also provided a similar training to 714 school managers across all target schools so that they can provide the governance conditions needed to support the new pedagogies. A final Early Grade Reading Assessment was administered to Grade 2 children in 70 schools (1,400 students). This will form a measure of comparison with midline testing that was done last year.

As the project ended, KAPE assisted World Education in administering endline EGRA instruments to determine program impact and observed 368 teachers during the 2019 school year. At the request of WE, KAPE also helped to distribute new curricular packages developed by USAID, though KAPE no longer has any direct involvement with USAID-funded reading programs, as the agency's strategic approach to improve reading is really quite different. The conclusion of KAPE's involvement in FFE will create a pause in KAPE's long-term partnership with World Education with whom the agency has been working since 2003; however, KAPE is hopeful that there will be future opportunities for us to work again with World Education.

Key Activities

1. School administrator training workshops
2. Administration of Early Grade Reading Assessments (Grade 2) to track improvements in reading proficiency
3. Development of teacher training manuals and the administration of numerous workshops aimed at teachers and school administrators across 503 target primary schools
4. Efforts to promote early grade literacy through the distribution of learning materials and Literacy Toolkits.

Goal

The goal of the Food For Education project is to increase literacy outcomes among children in the early grades (Grades 1 to 3). To achieve this goal, the project is working to increase the ability of school administrators (School Directors and their Deputies) to effectively promote early grade literacy activities at their schools. This refers in particular to improving the ability of teachers and librarians to effectively use Early Grade Reading pedagogies in their teaching. Key project interventions comprise teacher training, frequent monitoring and follow-up, continuous assessment, training manual development, and the provision of specialized literacy materials and games that are designed to promote self-learning as well as in-class activities.

Snapshot

Training Courses using specialized materials are provided to sharpen teachers' abilities.



Project Impact

During the last three years, FFE developed several teacher training modules focusing on literacy including:

- Module 1:** Language Acquisition and the Reading Process
- Module 2:** Developing as a Reading Professional
- Module 3:** Developing Literacy: A Managed Approach
- Module 4:** Evaluating and Assessing Literacy Practice

These manuals are easy to use and have many attractive games to strengthen teacher practice. They have played a major role in helping teachers to enrol in FFE's *Accreditation Pathway* in which teachers can get special credits for professional development, leading to improvements in their official status in the education system. The pathway provides opportunities for many personal development tasks such as self-study, directed activities, and self-assessment.

After three years of intervention, the FFE project has seen some modest improvements in reading proficiency in the schools where it has been working. Average EGRA Test scores at baseline demonstrated that only 16% of children could read at the proper grade level. By the end of the project, this had increased to 30%. Still, the project had hoped for much better results than these, suggesting the need for more intensive inputs.

Inclusive Education Program (IEP)

“Inclusive Education: Promoting the right to an education among underserved groups.”

In order to streamline the management and oversight of its school access-oriented programming, KAPE has created the Inclusive Education Program (IEP). IEP is an umbrella structure within KAPE that consists of four different projects. These include (1) the Cambodian Tertiary Scholarship Program (CTSP); (2) the STEM4Women Project; (3) the English Access for Micro-scholarship Program (Access); and (4) Kampuchea Young Leaders’ Action Project (KYLA). IEP aims to increase access to education at secondary and tertiary levels, especially for girls, minorities and other vulnerable and marginalized children/ youth. These programs also provide support for career counselling and confident workforce entry.

	Cambodian Tertiary Scholarship Program (CTSP)	Kampuchean Young Leaders’ Action (KYLA)	STEM4Women	ACCESS
Donors	The Asia Foundation	The OakTree Foundation,	100Women, Classroom of Hope, Navitas	U.S Embassy
Direct Beneficiaries	30	2,500	11	40
Budget Received in FY2019	USD 40,409	USD 39,999	USD 15,605	USD 18,790
Unit Cost per Beneficiary	1,347.00	16.00	1,419.00	470.00
Provinces Covered	Kampong Cham Tbung Khmum Kratie and Prey Veng	Kampong Cham Tbung Khmum	Kampong Cham Tbung Khmum	Tbung Khmum
Districts Covered	11	6	6	Krouch Chhmar
Target Secondary Schools	N/A	6	N/A	Peus II High School
Vocational Colleges/ Universities	Western University Kampong Cham	N/A	PNC institute, Rajamangkhal University, Burriram and Ubon Vocational College	N/A
Start Date	01 October 2016	01 January 2019	01 September 2017	30 November 2017
End Date	30 September 2020	31 December 2019	30 September 2019	30 September 2019



IEP interventions assist vulnerable Cambodian youth to access opportunities for secondary and post-secondary education. These educational opportunities provide them with the skills needed to prosper in the 21st Century. IEP provides support to both young men and women but places a high priority on young women from vulnerable backgrounds. The pictures above provide a sampling of some of the activities that the various IEP projects support.

From top left: CTSP Scholars: Attending workshops at University; engaging in team building activities, group discussion, and university-level research; **Access Program Students:** Training Activities; Donor Visit to beneficiaries; **STEM4Women Beneficiaries:** Donor visits students at Burriram and Surin; MoU-signing ceremony between KAPE and Ubon Rachathani University in Thailand; Ms. Morm Sopheaktra studies Food Nutrition at Ubon University; **KYLA Activities:** Youth attend an education forum on environment and recycling rubbish presentation on Trey Visay app.

Cambodian Tertiary Scholarship Program (CTSP)

"Educate a girl, educate a family"

Project Update

This project aims to support 30 female students (who passed the national Bac II Examination) from vulnerable families in Kampong Cham Province to obtain Bachelor's Degrees of their choice at Western University, a tertiary education institution in Kampong Cham Town. In 2019, the project completed 3 years of operation so that only one more year remains for beneficiaries to complete their degrees. So far, the project expects a 100% success rate for academic completion among beneficiaries. The current group of beneficiaries is the third cohort of vulnerable young women to receive support from CTSP. The project is a means for beneficiaries to achieve their highest vocational potential, leading to better job-placement and to positively transform them into role models for their communities. CTSP is being implemented by KAPE with funding and advisory support from The Asia Foundation. Both agencies work together to:

- Support CTSP scholars to study in a four-year degree program at Western University (WU);
- Develop a responsive Career Development Plan which includes a package of English language and computer skills, soft-skill trainings, exposure visits, club-study, leadership and networking;
- Engage the private sector and CSOs in the project, creating opportunities for CTSP scholars to undertake internships, and build their capacity for better job-placement.

Career Development Activities

- English language class
- IT training class
- QuickBooks training
- Monthly progress meeting
- Quarterly mentoring support
- Club study
- Alumni network
- Parent meeting
- CTSP retreat
- Exposure visit
- Soft skill training
- Community outreach
- Visibility event
- Donor visit

Program Result

- 7 out of 30 scholars (23%) received a Certificate of Appreciation for outstanding students from WU at the completion of Year 3 (August 2019).
- All 30 CTSP scholars (100%) successfully completed Year 3 at Western University (WU) in Kampong Cham Province, and have enrolled in Year 4 (September 2019-August 2020) classes.
- The CTSP scholars consistently performed better than most

other students in all five subject Majors.

- Since August 2019, 21 CTSP scholars were selected by ten local employers (NGOs and private companies) to work in 17 full-time and 4 part-time positions.
- 110 KAPE alumni attended the 5th Annual Alumni Re-union for former & current CTSP scholars and other KAPE scholarship recipients.
- 13 out of 15 career development activities (87%) were completely achieved in the 2018-19 Academic Year.

Ms. Phuong Soula is a Year 4 student, majoring in Banking and Finance at Western University. She has four brothers and her parents are farmers.

Soula is one of the outstanding students in the CTSP Program. She has been in the top ten students in her class since joining the program and is known as a kind and helpful classmate.

Through the CTSP scholarship, Soula has been able to attend many capacity-building activities such as club study, English language enhancement, and other soft skill programs including ICT Training. Soula has also been very active in CTSP monthly meetings and in working as a volunteer. She was also a leader of the English Reading Club and currently facilitates social work activities supported by the KYLA Project.

In September 2019, Soula was hired by ABA Bank to work as the Branch Concierge in Kampong Cham Town.



Ms. Thorn Navin is a Management Major and will complete her degree this year. Navin has been first in her class every semester since joining the CTSP program. She is a courageous and helpful person and likes reading books, helping friends to do financial tests, and socializing. Navin has realized several achievements including a writing award from The Asia Foundation, and a small grant from the Youth Resource Development Program (YRDP) to run workshops on Health & Education Awareness in rural areas. Navin also received a Debating Certificate from Western University recognizing her strong skills in critical analysis and expression. In September, Navin was hired as a recruitment officer at Buddhism for Social Development Action (BSDA), a large NGO in Kampong Cham Province.

At the end of the interview, Navin said, "I am very happy to work at an NGO to help young vulnerable people have choices in their lives. I'll try to learn from life in order to update myself. In the near future I hope I will eventually have a chance to be a Project Manager."

Kampuchea Young Leaders' Action (KYLA)

"Empowerment youth to be leaders"

Project Update

The Kampuchea Young leaders' Action Project (KYLA) is a new KAPE program. The project is funded by the Oaktree Foundation and Australian Aid and is implemented by KAPE in two provinces, namely Kampong Cham and Tbaung Khmum. The primary idea behind the project is to mobilize the hundreds of KAPE scholarship alumni who have received support through the years to organize advocacy and outreach services for young people who are still in school. This includes giving time and money to fund scholarships, organize awareness-raising workshops, and manage social media platforms to disseminate information. An Alumni Secretariat has been established to help coordinate the many activities organized by KAPE alumni.

Key Activities

- Provide training on leadership skill workshops (e.g., public speaking, communication, working as a team, problem solving, problem analysis, and networking)
- Provide training on Women's Empowerment Awareness Raising (e.g., Citizen's Rights & Politics, Economic and Cultural Rights)
- Updating social media platforms that inform youth of their career choices (e.g., Facebook, Idea sharing on Messenger & LINE, Developing Impact Videos)
- Provide training on storytelling and short-video creation
- E-counseling and career planning activities at school level
- Scholarship Alumni Meetings
- Attend meetings organized by the Education Sector Working Group (ESWGs)

Main Goal

To increase the opportunities for self-actualization among young people by empowering youth-based bodies to advocate for influence and re-sources that will benefit youth at multiple levels of society including educational institutions, local government, and in society in general."

Snapshot

Environmental Forums: Throughout the month of July, KYLA facilitated six environmental forums in 6 target high schools. The agenda for all of the forums was created in collaboration with both KYLA volunteers and high school students. The forum events were attended by the Provincial Office of Education from Tbong Khum, village chiefs, teachers, local government environmental representatives, parents and students. The forum showcased KYLA's ability to communicate and represent youthful ideas in a formal setting with important community stakeholders. In total there were 400-500 participants at these fora. The events gave KYLA participants the opportunity to practice their public speaking, presentation skills, and event planning. The forum gatherings addressed topics on the role of the natural environment in participants' lives and the effects of air pollution, deforestation, and solid waste pollution on their lives.



Volunteer students in six target schools do presentation at educational forum.

Exposure Visit to Phnom Penh: In August 2019, KYLA brought a group of students on an exposure visit to Phnom Penh. The group included 13 high school students from KYLA's six target high schools, 3 university volunteers, and 2 secretariat members. The group met with various organizations that advocate for social development and human rights such as Arow Dot Company. These exposure visits helped young people to better understand the process of advocacy, IT skills and social development.



In November 2019, KYLA project hosted Educational Career Counselling Forum via Trey Visay, Volunteer students from six target Schools do presentation on How to use Trey Visay App and Importance of using it to grade 9-12 students in order to get career choices for their future.



KYLA Secretariat invites Communication Specialists from the InSTEDD iLab to work with secondary school students considering further studies: Students learn more about storytelling related to video filming using mobile devices and laptops, hardware maintenance, and software development.

STEM4WOMEN

"Education Transforms Lives of Cambodian Women."

Project Update

KAPE, in partnership with Classroom of Hope (CoH), seeks to empower young, vulnerable girls/women to join a global movement that promotes increased female participation in the subjects of Science, Technology, Engineering, and Math (STEM). This year, the STEM4Women Project, funded by Navitas and Classroom of Hope and implemented by KAPE, came to a conclusion. The project enabled 11 young women to attend two-year tertiary institutions offering subjects in STEM. KAPE has negotiated Memoranda of Understanding with several tertiary institutions to receive selected students in both Cambodia and Thailand. These institutions include Rajamangla University of Technology Isan in Surin (Thailand), Ubon Rachthani Vocational College (Thailand), Buriram College of Agriculture and Technology (Thailand), and Passerelle Numerique – PNC (Cambodia). The program has been able to negotiate very favorable conditions of study at these institutions (e.g., free tuition and accommodation), which has greatly leveraged project funding. Program beneficiaries come from vulnerable households where young women often have little chance to further their education.

Primary Goal

To empower young vulnerable women in Cambodia to enter professions in the STEM disciplines, which are currently dominated by men.

Supported Majors:

- Food Chemistry
- Art Design
- Food Processing
- Plant Science
- Accounting
- Business Computer
- WEP Programming
- System Network Administration

Ms. Meas Chheng Seang is 20 years old and was awarded with a STEM4Women scholarship in 2018. She is majoring in Food Chemistry at BCAT College in Buriram Province, Thailand. She is an outstanding and hardworking student and recently achieved a GPA of 3.58 at the end of her first year of study. She has very strong English language skills and is one of the best students in her class. Seang studies all her classes in Thai language and has become multi-lingual as a result of the STEM4Women Program. In May 2019, she interned as a Quality Assurance Officer at a large car manufacturer in Thailand and is scheduled to return to Cambodia with an Associates Degree in Food Chemistry in 2020.



Ms Meas Chheng Seang
Food Chemistry Student



MoU between KAPE & Ubon University



Ms. Morm Sopheakra studies Food Nutrition at Ubon University in Thailand



The donor and KAPE's IEP coordinator visit STEM4WOMEN scholars at Ubon University in Thailand.

Ms. Samai Duch successfully graduated with an Associate's Degree in Web Design from Passerelle Numerique Cambodia in August 2019. She is currently working at Rotati Consulting Firm as a Software Developer and has been involved in developing a children's tracking system to help NGOs improve their service delivery. She likes her working environment at Rotati and meets interesting people there everyday. Samai is the only one in her family to have completed higher education. Her other siblings all dropped out of school when they were in primary school. Samai's mother passed away while she was studying at secondary school but is sure that her mother would be so proud to see her with a university degree and working in a large office in Phnom Penh.



Ms Samai Duch
Software Developer



Ms. Thai Youlen attended the parent day.

English Access for Microscholarship Program (ACCESS)

"To provide English language skills and knowledge of U.S. culture through a fun learning environment".

Project Update

Access is a global scholarship program that provides a foundation in English language skills to bright, economically disadvantaged students, primarily aged 13 to 20 years old, through various enhancement activities. Since 2004, over 115,000 students from over 85 countries have participated in an Access Program. KAPE has now also received funding from the US Embassy to run its own ACCESS programming.

KAPE has been running the ACCESS program for 2 years (2017-19) with 40 students from Samdech Hun Sen Peus II HS in Tbaung Khmum Province, funded by the U.S. Department of State. The students learn strong English language skills that can lead to better jobs and educational opportunities. Although the project ended in September 2019, KAPE is negotiating a likely one-year extension from the US Embassy that will hopefully start in the 2020 academic year.

Project Impact

- 100% of Access students have successfully completed intensive English classes regularly each year.
- All 40 Access students attended an Exposure Visit to the US Embassy in Phnom Penh involving special inter-school meetings with other students who had participated in the Access Program.
- All Access students attended a foundational training on Goal Setting.
- 15 Access students attended an event organized by FUSAAC about post-secondary scholarship opportunities in North America.
- 40 Access students attended an English camp facilitated by the U.S. embassy.
- All students participated in a community development project involving raising the awareness of the need for recycling among primary school students.
- Students learned about supplementary skills like ICT that helped them to intensify their English language learning.



Access students attended intensive English class from Monday to Friday.



40 students have successfully completed their two years English study in Access program. This is a Graduation Ceremony day which students received the certificate from US Embassy Representation in Cambodia.

Donor Visit from US Embassy: Several representatives from the US Embassy visited Access students at Samdech Hun Sen Peus II HS to learn about the project's achievements. Here, an embassy representative converses with 4 target students at the school about the relationship between US and Cambodian culture and how the program has helped them to improve their sense of being a global citizen.



Primary Goal

To improve students' knowledge of U.S. culture, English language skills, and critical thinking skills through creative teaching techniques.

Key Activities

- 8 hours of Intensive English per week
- 2 hours of ICT Instruction per week linked with English Language Instruction
- Over 600 instructional hours of intensive English for each student
- Special educational support including subsidies for bicycles, school bags, food, and English books
- Community service projects
- Personal development activities
- Hydroponic life skills
- U.S cultural awareness
- English camp, Interschool Meetings, and Exposure Visit to the US Embassy
- Parental engagement and outreach
- High Profile Graduation Ceremony with US Embassy Representation

Exposure Visit to US Embassy in Phnom Penh: A team of 44 people including Access students, their teachers, and KAPE staff members were invited to the US Embassy as part of an Exposure Visit to raise students' awareness about the importance of English. Students attended a meeting about applying for tertiary level scholarships to educational institutions in the United States followed by a tour of the Embassy. This was an amazing and inspiring experience for students from a rural setting. Students visited the Jacqueline Kennedy Room and learned about her role in improving relations between the United States and Cambodia back in 1967. The embassy also organized a number of inter-school visits with the Sustainable School International (SSI) and the Liger Institute, where students could talk and share ideas. The visit lasted for 3 days and provided KAPE-sponsored students with a life-changing experience that will likely have a major influence on their future planning.

Happy Cambodian Children (HCC) Project

"Learning to read, Reading to learn"

Project Profile

Donor	Kinchan Siftung Foundation
Direct Beneficiaries	Total Students: 8,498 Minority Children: 2,188
Budget Received in FY2019	\$587,478
Unit Cost per Beneficiary	\$69
Provinces Covered	5 (Siem Reap, Kratie, Tbaung Khmum, Kg Cham, Ratanakiri)
Districts Covered	8
Target Primary Schools	25
Start Date	August 01, 2018
End Date	Open-ended

Project Update

The Happy Cambodian Children Project (HCC) underwent a name change in 2019 from United Schools of Cambodia (UKC). The project started in August 2018 with funding from Kinchan Siftung Foundation. The project focuses on supporting children in the most rural and remote communities in 4 provinces, which present great challenges in terms of the availability of human resources in target schools, logistical monitoring, and dilapidated infrastructure. Teacher shortages are one of the primary problems that the project is trying to address. Baseline tests on reading have suggested catastrophically low levels of reading proficiency with 75% of children in Grades 1 to 3 unable to read a single word. Although these Zero Scores declined to 42% at Midline after one year of programming, this is still unacceptably high, and will require many years of strategic investment.

Key Activities

- Support pre-school activities in one site (Hanchey Commune)
- Provide intensive support for Enhanced Reading Services using what is known as the Total Reading Approach for Children (TRAC). This involves rigorous continuous assessment based on MoEYS Reading Benchmarks and systematic pairing of struggling readers with key interventions such as peer-tutoring, special borrowing privileges at the library, and parental home visits to engage parents in their children's reading.
- Library Upgrading to ensure attractive reading environments, copious access to books and learning materials, and improved management.
- Massive investments in Infrastructure Upgrading with a focus on masonry repair, tiling, painting, ceiling emplacement, furniture refurbishment, and toilet repair.
- Establishment of Children's Councils to improve children's ownership of the school and improved governance.
- Library upgrading and access to Reading Toolkits that are closely linked to the curriculum.
- Administration of external Early Grade Reading Assessments (EGRA) at baseline and midline to monitor impact on learning outcomes.
- Classroom Enhancement including the provision of teaching & learning aids as well as training on how to use aids.
- Scholarship Support to the most vulnerable children.
- Support for Life Skills Instruction for children in Grades 4 to 6 with a focus on both soft and hard skills.
- Community Outreach to strengthen parental engagement in children's learning.
- School Coordination Committee establishment to improve planning, stakeholder engagement in education, and maintenance of school infrastructure.
- Stakeholder-driven School Planning following logical framework approaches to identify problems, solutions, rationalized budgeting, and monitoring.

Main Goal

- **Project Objective 1:** Access to education (especially for girls and vulnerable children) improves in target locations;
- **Project Objective 2:** School effectiveness (i.e. quality of education) improves through the development and practice of Child Friendly School approaches in and out of the classroom in a way that is relevant to needs of vulnerable children, especially girls;
- **Project Objective 3:** Children's reading abilities improve from a baseline in the early grades (Grades 1-3)
- **Project Objective 4:** The management capacity of local partners to administer development assistance increases in a way that enhances educational access and quality as well as community outreach.

Snapshot



↑ Exposure visit for target schools

↺ Training on Reading benchmarks

Providing scholarships to vulnerable children ↓



Enhanced library reading services

Easy2Learn (E2L) Project

"Integrated Project Designs Ensure Long-Lasting Impacts on Education."

Project Profile

Donor	Child Fund Cambodia
Direct Beneficiaries	9,736 boys (4,843 girls)
Budget Received in FY2019	\$337,300
Unit Cost per Beneficiary	\$25/per individual
Provinces Covered	Svay Rieng
Districts Covered	2 (Svay Chrum & Romeas Haek)
Target Primary Schools	28 Schools
Target Secondary Schools	2 Schools
Start Date	1 January 2015
End Date	30 June 2019

Project Update

The E2L Project came to a conclusion in June 2019 after a 4 and a half year development cycle. Nevertheless, the project retains a strong reputation for high impact at reasonable cost (e.g., \$25/child). E2L is a programmatic hybrid that combines some of the best programming ideas developed by KAPE over the years into one project. This includes programming on early grade reading, library development, life skills education, ICT in education, and many others. By developing the project in this way, E2L has evolved into one of KAPE's best examples of an 'integrated' program that addresses multiple dimensions of a child's learning environment (e.g., inclusivity, classroom learning environments, parental engagement, etc.) simultaneously. As the project came to an end this year, the donor engaged an external evaluator to assess programming impact as well as the logic of its design. This evaluation has given high marks to the project and has recommended replication in Prey Veng Province in 2020. These activities should be underway by March 2020.

Key Activities

- Promoting access to education through scholarships for poor children and health referral services for those who are physically challenged.
- Improving the quality of education through Child Friendly School development, which focuses on multi-dimensional inputs across the six dimensions of the CFS Framework
- Addressing teacher shortages through local teacher recruitment (e.g., PTTC Scholarships) and appointment of Community Teachers
- Improving early grade literacy through the use of reading benchmarks, reading toolkits, 21st century library facilities, & technology.
- Supporting Leadership and Management Training for school managers as this relates to school grant programming.
- Promoting engagement from parents & communities through the development of School Support Committees & Commune EFA Committees.
- Enhancing transition and retention at secondary school level.



A Children's Council raises awareness about its role to students & parents

Main Goal

The goals and objectives of the E2L Project continue to be highly convergent with the Child Friendly School Policy framework of the Ministry. In this respect, schools develop plans across the six dimensions of the policy while the project provides technical inputs focusing on educational access, quality, and management. The official goal framework of the project is summarized below:

Project Goal: The program's purpose-level goal is to develop child friendly school models that are truly excellent across several dimensions including educational quality, inclusiveness, and local stakeholder engagement.

Project Objective 1: Access to education (especially for girls and vulnerable children) improves in target locations;

Project Objective 2: The effectiveness of education improves through the development and practice of Child Friendly School approaches that are relevant to the needs of all children, especially vulnerable children and girls.

Project Objective 3: Children's reading abilities improve from a baseline in the early grades (Grades 1-3)

Project Objective 4: The management capacity of local partners to administer development assistance increases in a way that enhances educational access and quality as well as community outreach.

Snapshot



Monthly meeting with District-based Training & Monitoring Team



Sustainability Workshop with School and Community Stakeholders: As the E2L Project came to a conclusion, program personnel held multiple meetings with stakeholders in each school to review the most important impacts achieved by the project and how these impacts can be sustained without project support.

Program Expansion to Secondary School Level

Since 2017, the E2L Project has organized an important expansion of its programming to lower secondary school level (Grades 7 to 9). The two selected schools receiving technical and material support are located in areas close to feeder primary schools that are also supported by E2L. This strategy will ensure that students in project primary schools who are completing Grade 6 will be able to transition to secondary schools that also have educational services, which are characterized by relevance and good quality. Investments in secondary schools include support for scholarships, enhanced science education, ICT instruction, and improved Life Skills Education that make local education more relevant to the local context. This includes Life Skills instruction in Socially Relevant Skills (e.g., Drug Abuse Prevention); Economic Life Skills (e.g., Market Skills, Market Simulations, etc.), and Pre-vocational Skills (e.g. Vegetable Cultivation, Hair-cutting, etc.).

Snapshot



Market Simulation



School Support Committee Meeting



School Support Committee Meeting



Working group meeting to engage support from the Provincial Teacher Training Center.

Library Activities: Students are motivated to use the Smart TV to watch videos and story books to read during their break.



Project Impact

E2L has had many diverse impacts on educational services in Svay Rieng Province, some of which are highlighted below:

- ◆ School Leadership and management has changed by promoting engagement from parents & communities using such mechanisms as support to the School Support Committee, Coaching Workshops on Leadership, and Exposure Visits.
- ◆ School and community resource mobilization/ engagement has improved markedly both as a result of increased parental giving as well as more active parental & community engagement in school planning and development.
- ◆ School managers have become more literate in the use of ICT to improve how they manage data and communicate with stakeholders. The provision of computers and ICT training has enabled school managers to better organize school statistics, student grades, attendance information and other data. School managers now also increasingly rely on social media (e.g., Facebook, Telegram) to achieve rapid communication with stakeholders and disseminate information more effectively.
- ◆ Teacher Consciousness with respect to educational quality issues has also changed markedly with improved awareness of the importance of reading and how the use of educational software, library services, and Literacy Toolkits can play a key role in improving children's learning.
- ◆ Student behaviours and attitudes towards school have changed markedly due to major improvements in the learning environment at target schools including the emplacement of attractive 21st Century Libraries with m-Learning services, life skill gardens, playgrounds, and renovated classrooms. Enrolment is now up and absenteeism is down.
- ◆ Library services have changed significantly with the development of new library designs that are colourful, attractive, and modern. These are known as 21st Century Libraries. The new library designs facilitate story-telling activities, m-Learning and access to educational software on tablets, as well as improvements in the number and diversity of children's books. Librarians have been extensively trained about managing library facilities, maintaining regular hours of access, and strengthening links with classroom activities in order to ensure that diverse learning needs can be effectively addressed.

Quality Learning Environments Expansion (QLE)

"Promoting Learning Environments for Growth"

Project Profile

Donor	Norad/Save the Children
Direct Beneficiaries	7,763 students
Budget Received in FY2019	\$57,834
Unit Cost per Beneficiary	\$7.44
Provinces Covered	2 (Kampong Cham, Tbaung Khmum)
Districts Covered	9
Target Primary Schools	17
Start Date	1 January 2016
End Date	31 December 2020

Project Update

After 3 years of implementation (2016 to 2018), the QLE project entered a period of consolidation that will last for two years (2019-20), focusing mainly on schools in Kampong Cham and Tbaung Khmum Provinces. The project's development strategy is based on the 'QLE Framework' developed by Save the Children and includes inputs into Four Key Principles including: 1) Emotional and Psychological well-being; 2) Physical Protection; 3) Active Learning (and improved learning outcomes); and 4). Parent-Community Participation. The QLE Framework seeks to promote a more holistic approach to educational development and shares many similarities to the philosophy of MoEYS' Child Friendly School policy.

Consolidation efforts this year have focused on inputs to support children's learning both in the school and at home. The project continues to place a special focus on promoting early grade reading and has worked closely with schools to set up 'reading camps', promote testing, and improve the operation of school management committees that promote reading activities. This approach builds on Save the Children programming known as Literacy Boost.

The QLE Project has also continued to work closely with Provincial and District Offices of Education to establish school-to-school assistance networks to enable schools to provide on-going technical support to one another.

Key Activities

- Establish working groups at provincial and district level to strengthen local control and engagement in project implementation.
- Provide teacher training support in the instruction of Khmer Language, Mathematics, and Life Skills as well as the four key elements of the QLE Framework.
- Establish school management committees to facilitate easy points of contact for implementation.
- Establish classroom committees to help teachers and improve their children's study.
- Establish children's councils to influence school planning and budgeting.
- Establish community-reading camps to promote reading out of school and help slow learners.
- Train teachers to promote inclusive education.
- Facilitate school self-assessments and stakeholder driven planning and development.

Goal

The QLE Project Goal: Primary schools in Cambodia improve performance and provide better learning outcomes.

Snapshot



Capacity building support through training, meetings, and workshops.



Reading Camp and Children's Council Activities

Project Impact

During the last year, the QLE Project Team worked in collaboration with local officials, head teachers, and Save the Children colleagues to re-organize 7 of 17 school management committees to have a clearer sense of their roles and responsibilities in order to improve school development activities. In addition, all target schools established student councils and classroom committees to play key roles in managing and maintaining classroom environments.

The project also established two new reading camps and re-organized 8 others to improve activities for reading reinforcement and writing educational games, and remedial learning. After school, children helped to produce hand-made learning materials that can be used by all children using the camp facilities.

Program personnel also helped to organize sharing activities between schools so that the better-organized schools could assist the weaker ones. This included exposure visits, joint workshops, and efforts to improve community engagement.

Five schools established inclusive education classrooms in response to a campaign to improve schools' responsiveness to marginalized children with special needs and disabilities. Save the Children personnel assisted KAPE and local education officials to provide a training workshop to help schools better understand how to detect special needs and respond to them effectively. This includes the use of special seating arrangements and learning materials such as reading cards, pictures, and other attractive educational materials.

An overview of school efficiency statistics at the end of the 2018-19 academic year indicated that 86% of the 7,763 children in target schools had passed their annual examinations and were promoted to the next grade while 11% did not and were repeated. Another 3% of children, mostly in the upper primary grades dropped out completely and left school. Project personnel sought to help each school review this data in order to identify suitable activities to respond to them.

Total Reading Approach for Children (TRAC III)

"Pioneering New Approaches to Children's Literacy"

Project Profile

Donor	The Phoenix Foundation
Direct Beneficiaries	2,540 Students; 1,176 Girls
Budget Received in FY2019	\$160,158
Unit Cost per Beneficiary	\$63
Provinces Covered	2 Provinces (Kampong Cham and Tbaung Khmum Provinces)
Districts Covered	5 Districts
Target Secondary Schools	N/A
Target Primary Schools	12 Schools (increasing to 18 in 2020)
Start Date	1 st July 2017
End Date	30 th June 2022 (Extension Approved)

Project Update

The TRAC III Project has completed 2 years of implementation successfully in 12 target schools in Kampong Cham and Tbaung Khmum Provinces. Although the project was scheduled to end in 2020, the Phoenix Foundation has now agreed to fund a two year extension that will enable 6 more schools to join the project (Cycle 3 Schools), bringing the number of supported schools to 18, starting in 2020. In addition, the project will add an ECCD Component using 21st Century techniques and technology that will help programming to further enhance early grade reading at primary school level. The TRAC III Project employs a unique mix of interventions that focuses on continuous assessment based on reading benchmarks developed in earlier iterations of the program. Assessment information helps to identify children with special reading needs followed by the rapid provision of an array of services to help them achieve required performance benchmarks. Assessment information helps to identify children with special reading needs followed by the rapid provision of an array of interventions to help them acquire required performance benchmarks.

Key Activities

Multi-dimensional Investment in:

- Emplacement of Enhanced 21st Century Libraries
- Recruitment and Training of Literacy Coaches to Coordinate Literacy Interventions and Improve Educational Governance
- Continuous Assessment
- Peer Tutoring
- Educational Software to Promote Literacy linked to M-learning
- Enhanced Parental Engagement in Learning
- Access to Literacy Toolkits and Classroom Enrichment
- Rapid Response to Needs Identified during Assessments
- Digital Testing



New Educational Software Promotes Early Grade Reading Proficiency: H.E. Chan Sophea from the Primary Education Department observes children using new educational software developed under TRAC to reinforce reading skills.

Goal

The Total Reading Approach for Children Project (TRAC III) aims to promote children's acquisition of essential early grade reading skills through an approach that focuses on the totality of the child's learning environment including classroom learning and assessment as well as parental reinforcement.

Snapshot



Enhanced Library Services: Children can access special Reading Toolkit Materials that facilitate self-study and reading reinforcement during break times and library periods.



Emplacement of New 21st Century Libraries in Cycle 2 Schools. During the year, six new schools, known as Cycle 2 schools, joined the program requiring the emplacement of new 21st Century Libraries in each school. These are new style libraries designed by the project that provide M-learning services as well as attractive and more functional physical designs that facilitate story-telling and self-study.

Program Impact

- 1) **Relatively Better Return on Investment than Similar Projects Supporting Early Grade Reading:** The results of independent Early Grade Reading Assessments in target schools have shown major improvement from baseline values across all grades including major declines in the number of Zero Scores. These results demonstrate that improvements in reading proficiency can be achieved simply through improvements in school governance and student assessment without additional changes to the national curriculum.
- 2) **Significant Reductions in the Number of Students Scoring Poorly on Reading Proficiency Tests:** Interval Test scores at the end of discrete curricular periods indicate dramatic declines in the number of children performing below standard reading benchmarks.
- 3) **Digitization of Formative Testing:** During Year 2 implementation, TRAC III has completed the introduction of digitized testing using specialized software linked to the national curriculum in all Cycle 1 schools.
- 4) **Strong Literacy Coach Performance:** The project has been very fortunate to engage individuals as Literacy Coaches who have shown high levels of competence.
- 5) **Emplacement of Modern Library Facilities in All Schools:** During the year, the project was able to complete upgrading efforts in all school libraries bringing the number of 21st Century Library facilities to 12.
- 6) **Highly Positive Fidelity of Implementation Assessments (FoI):** Results by and large indicate high levels of fidelity in implementation and corresponding improvements in reading proficiency among children.

Reinforcing Education Access with Community Help (REACH III)

"Strong Communities Build Strong Schools"

Project Profile

Donor	We World
Direct Beneficiaries	17,605 (8,675 girls)
Budget Received FY2019	\$368,046
Unit Cost per Beneficiary	\$21
Provinces Covered	4 Provinces: Svay Rieng, Prey Veng, Kampong Chhnang and Pursat
Districts Covered	8 Districts in Total: 2 districts in Svay Rieng, 1 district in Prey Veng, 3 districts in Kampong Chhnang and 2 districts in Pursat
Target Primary Schools	38 schools
Start Date	January 2019
End Date	December 2020

Project Update

The REACH Project originally began in 2012 and has already completed two 3-year development cycles (REACH I and II). REACH III is now the third iteration of REACH programming and has been approved for a two-year implementation cycle, the first year of which has just been completed. In 2020, REACH III is focusing on intensified efforts to sustain the work started under REACH I and II and will introduce some new concepts of programming such as *Early Warning Systems* and *Accelerated Learning* to ensure efficient transitions to secondary school for children completing the primary school cycle. Starting in 2020, REACH III will be closely linked with an EU-funded project called *Strengthening Education and Employability in Kampuchea* or *SEEK*. This project will help link primary school programming under REACH with access to local secondary schools including enhanced services for career placement.



Using mobile devices to administer formative tests in reading.



Life Skills Learning: Grade 5 Students in Tradet PS learn about Integrated Pest Management using agricultural techniques designed to protect the environment.

Goal REACH III's objective is to enhance the Child Protection and Learning Impacts of children in multiple areas including numeracy, literacy, and life skills through integrated strategies that promote improved and sustained governance as well as higher quality learning environments both in the school and at home within the 4 target provinces

The REACH Project is another one of KAPE's larger projects that uses a holistic development approach to address multiple aspects of a child's learning environment including access, learning environments, community engagement, child protection, etc. as per the Child Friendly School Policy.

Key Activities

The REACH III Project continued to focus on improvements in school access, quality, and educational management. Some of the key activities during the year included the following:

- ◆ **Strengthening Reading Proficiency:** Continuing roll-out of the *Total Reading Approach for Children*, which is a development methodology that strengthens teacher accountability for student performance. TRAC implementation entails rigorous continuous assessment and analysis of test data to identify children most in need of support followed by referral to special school services (e.g., Peer to Peer Tutoring, Remediation Classes, M-learning services, Home visits, Access to Reading Toolkits, etc.).
- ◆ **Pre-school Enhancement:** One of the key strategies for improving children's readiness before entering Grade 1 is the availability of Preschool services. REACH has ensured that ALL target schools now offer preschool services of very high quality.
- ◆ **Child Protection Strengthening:** KAPE and WeWorld have created an Early Warning System (EWS) that tracks children at risk using key warning signs such as high absenteeism, indications of abuse, frequent sickness, and other indicators. These children receive special support such as Home Visits, access to Emergency Fund resources to improve attendance, and other measures.
- ◆ **Enhanced Learning Environments:** Schools continue to receive both guidance and material support for the enhancement of learning environments such as through the provision of Literacy and Numeracy Toolkits, Children's Games, Books, and other materials.
- ◆ **Enhanced Community Engagement:** The project continues to stimulate community engagement through a combination of outreach activities, SSC strengthening, and Home Visits for children at risk.



Enhanced Learning Environments at Pre-school: REACH III continues to enrich pre-school learning environments as an important measure to ensure that children start primary school with some basic understanding of literacy and numeracy concepts.

Project Impact

Rigorous collection of assessment data continues to demonstrate impact on learning outcomes in target schools. Some of these impacts are reported below:

• **Child Friendly School Development:** Compliance with Child Friendly School standards set by the Ministry continue to be better in intervention schools than in control schools.

• **Improvements in Reading Proficiency:** Early Grade Reading Assessments at midline continue to show better performance among children in target schools than in control schools. Midline assessments administered in August 2019 indicated that children in REACH schools could read at a rate of 14.46 words per minute on average compared to 13.61 words per minute in control schools.

• **Overall Enrollment:** School data indicated a continued decline in the number of over-aged children enrolled at Grade 1.

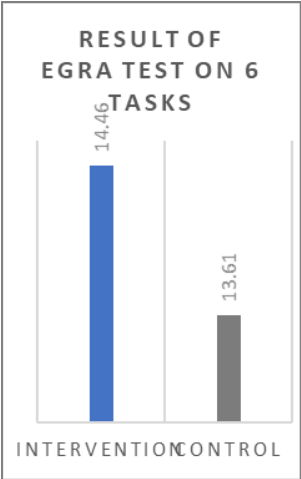
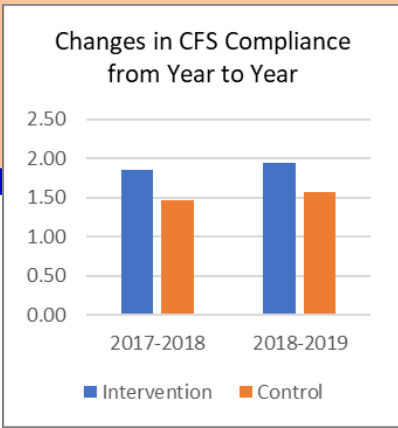
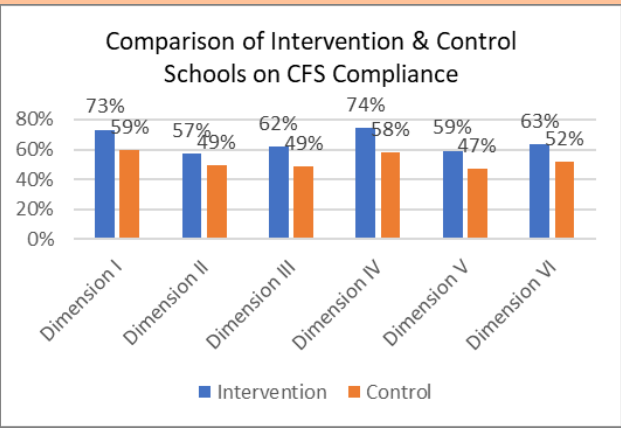

Children's Councils: REACH III has provided computers to all schools to be used by both school managers as well as Children's Councils. Students are trained in how to use the computers and prepare PowerPoint Presentations to help them communicate issues and problems at their respective schools.

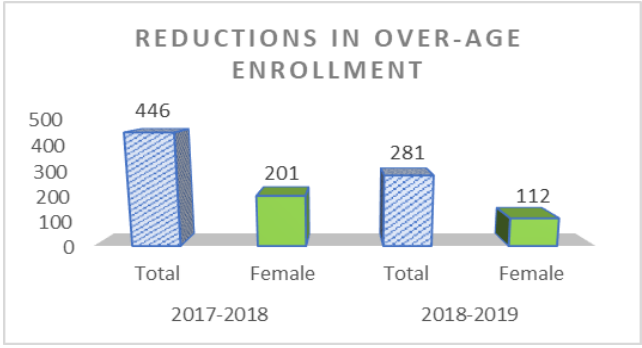

◆ Children's Councils in REACH schools outperformed those in control schools by a margin of 63% versus 35%. KAPE uses standardized assessment tools to determine how well councils are functioning based on agreed standards.

◆ The introduction of computers at target schools has increased management efficiency at all schools. Schools that received computers and printers were more efficient in writing reports, tracking data, and communicating electronically with POE, DOE, and KAPE staff, especially with regards to the transmission of reports (in soft copy) and data.

◆ School surveys also indicated that physical environments both inside and outside of classroom have shown continuous improvement from when the project first started.

Scholarship students receive school kit materials in Prah Chor Primary School. ➔



30 LIFE SKILLS LEARNING FOR ADOLESCENT GIRLS (LSLAG) Project

"Providing the capacity for girls to live effectively in society"

Project Profile

Donor	Gap Inc.
Direct Beneficiaries	12,110 (Girls)
Budget Received in FY2019	\$ 45,000
Unit Cost per Beneficiary	\$ 3.72
Provinces Covered	2 (Kg-Cham, Tbaung Khmum)
Districts Covered	11 Districts
Target Primary Schools	0
Target Secondary Schools	23 Schools
Start Date	01 Dec 2018
End Date	30 Nov 2020

Project Update

The LSLAG project is a new KAPE project focusing on the development of new curricular materials as well as adapting existing materials that were developed earlier in other related projects. Links were especially forged with a series of life skills modules focusing on soft skills that were developed collaboratively with MoEYS through funding support from USAID. These modules have now been officially adopted by MoEYS and are a part of the national curriculum. The project also provides training workshops to core teachers from target schools. A Master Trainer Team (MTTs) was established as well and comprises members from Provincial and District Education Officials working on PACE implementation.

The challenges in implementing the LSLAG Project relate to an overloaded school curriculum with little flexibility to accommodate life skills topics. Project staff have sought to resolve these challenges by working with school directors to maximize access to life skills hours that are available in the official curriculum (2 hours per week).

Key Activities

- Project Start Up Activities: Work plan development, Branding Guidelines, etc.
- Conduct meetings with school directors and local officials to select teachers for the program. Teachers and other relevant school stakeholders received orientations about the proposed program in order to determine whether they would be willing to join the program or not.
- Set up a Project Working Group (PWG) with representatives from Secondary Education Department (SED), Vocational Orientation Department (VOD), Curriculum Development Department (CDD), and Primary Education Department (PED), as well as District and Provincial Offices of Education. The PWG meets quarterly to oversee the project performance, receive reports, and resolve problems as they arise.
- Project Launch Event in Kampong Cham Province with participation from target school directors, PWG members, & relevant partners.
- Contextualize and finalize curricular materials for both younger and older girls including teaching modules, student workbooks, and other materials for utilization by schools.
- Print teaching modules and student worksheets.
- Provide 6-day TOT Training for Master Trainers followed by an 8-day Foundation Workshop for teachers and school directors.
- Implementation of modular curriculum and teaching in all target schools by trained teachers. Incentives for teachers teaching this curriculum will be the same as official government overtime provided by MoEYS. One module will be taught in each semester so that within two years, each target subgroup of students will have completed all 4 modules intended for that age group.
- One-day annual reflection workshop conducted for all teachers to identify successes, challenges and solutions for better implementation.
- Schools organize school fairs in which target classes and teachers in each school can share results/learning products with other students and parents as well as local authorities with regards to their knowledge and skills from learning through verbal presentation, role plays, diagram displays, question and answer, etc.

Goal

The purpose of the LSLAG Project is to make the process of healthy and positive transition into adulthood while recognizing and addressing gender vulnerability and inequality”.

Key objectives include:

1. Building the skills and efficacy of adolescent girls to be confident, resourceful, and effectively plan for their futures.
2. Building efficacy for girls to enable them to negotiate the physical, mental, and social transitions during adolescence that have important implications for outcomes in adulthood.

Snapshot

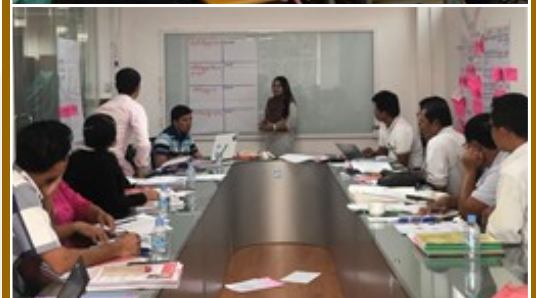

Foundation Workshop (above) and follow-up activities with young girls in schools (below)

Teaching Improved Gender Equality and Responsiveness (TIGER)

"Boys and girls have equal rights to access school free of violence."

Project Profile

Donor	European Union, VVOB
Direct Beneficiaries	4,800 girls and 4,800 boys in 40 primary and lower secondary schools
Budget Received in FY2019	\$ 32,801
Unit Cost per Beneficiary	\$3.42 per student
Provinces Covered	Battambang Province
Districts Covered	Battambang Town
Target Secondary Schools	20 schools
Target Primary Schools	20 schools
Start Date	1 October 2017
End Date	30 th September 2020

Project Update

Action Guide Development: During the second year of the TIGER project, the consortium partners brought together a skilled and gender-balanced team to work together on achieving the project's outcomes and objectives. The first draft of an *Action Guide* designed to develop gender-sensitizing training programs has been endorsed by MoEYS and widely used within trainings provided to schools and Teacher Education Colleges (TEC). In this regard, TIGER has rolled out the *Action Guide* to [pilot in 20 target schools as well as target schools](#) supported by 20 other CSOs. The *Action Guide* and subsequent training was very positively received by school directors and teachers according to reflection workshops at the end of 2019. A series of both local and national level consultative workshops to revise the *Action Guide* were also completed during the year, thereby enabling the project to finalize the *Guide* on schedule.

Action Guide Adoption: The TIGER team [also shared the lessons learned during the piloting of the Action Guide to the National Working Group](#), thereby leading to a decision to start partial dissemination of the *Action Guide* in September 2019. The *National Working Group* will conduct follow-up meetings again during Year 3 implementation to prepare for official adoption of the *Action Guide* by MoEYS.

Using Technology to Promote Gender-based Violence Awareness: The TIGER Team also made significant progress in digitalizing gender-focused assessments of school environments as well as in developing an interactive story-telling app that helps young people better understand the consequences of gender-based violence.

Key Activities

- Provided 13 successful trainings on gender-responsive school leadership and pedagogy to 474 (269 female) teachers, school leaders and school support committee members in 20 primary and lower secondary schools.
- Piloted a first draft of an *Action Guide* designed to guide gender-responsive training in 20 target schools as well as schools in the target areas of 20 other CSOs.
- Digitalized the School Response to Gender Equality Assessment: <http://bit.ly/assessmenttigger> which enables school directors to conduct self-assessments of their schools.
- Developed an interactive storytelling app to promote self-learning about the consequences of gender-based violence: <http://bit.ly/tigermobile>. This app is a major innovation in the use of technology to promote electronic story-telling in a way that promotes self-learning without the mediation of a teacher or trainer.
- Conducted Reflection Workshops with stakeholders to improve the delivery of project mediated services.
- Shared the lessons learned during the year to the TIGER National Working Group.

Goal

Overall Objective: To ensure primary and lower secondary school children are protected from school-related gender-based violence, enabling their equitable participation in all spheres of life at school and at home.

Specific Objective: To transform the Teacher Education College and 40 schools in Battambang Province into centers of excellence for gender-responsiveness.

Project Scope: 4,800 girls and 4,800 boys in 40 primary and lower secondary schools in Battambang Province will derive benefit from the project over the course of its implementation.

Snapshot



Workshop on the finalization of Action Guide for Gender Responsiveness provided more outcomes to submit to the Ministry for approving to use at schools national wide.



The research team of Royal University of Phnom Penh presented the results of TIGER Mid-term Evaluation to PoE, BTEC, CSOs and 20 target schools.



The meeting with the Provincial Officials of the Ministry of Women's Affairs focused on gender equality in education in Battambang.



Workshop on the Action Guide for Gender Responsiveness attended by the core teacher trainers and teachers.

Students use their understanding to produce handicrafts during school fair.

Financial Highlights

Cash Assets and Expenditure

Description	Amount (USD)
Total Project Revenues FY2019	3,760,790.54
Balance Forward from FY2018	208,699.24
Interest Income	367.98
Available Assets in FY19	3,969,857.76
Total Expenditure in FY19	3,561,576.78
Fund Utilization Rate	90%

Fund Receipt Trend

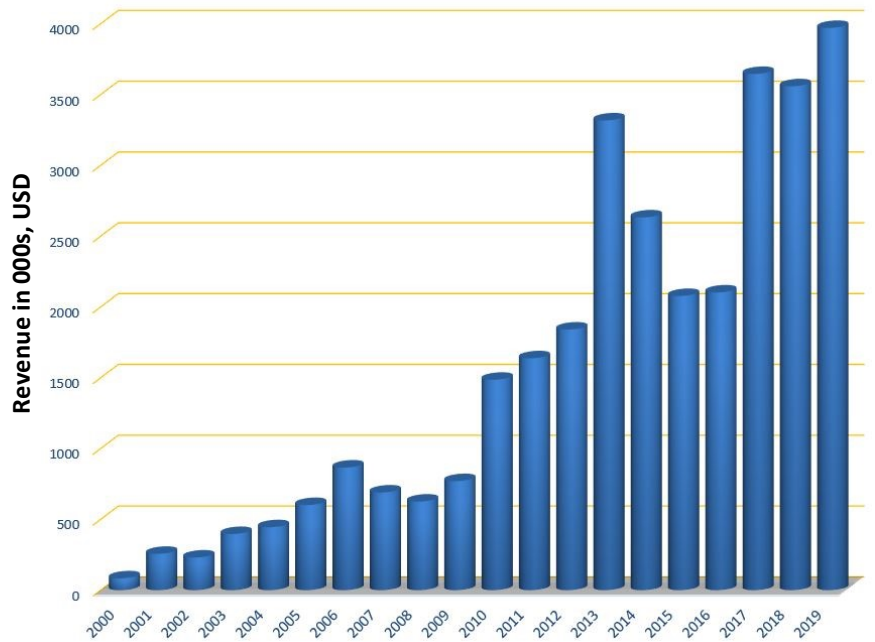

How was the money spent?

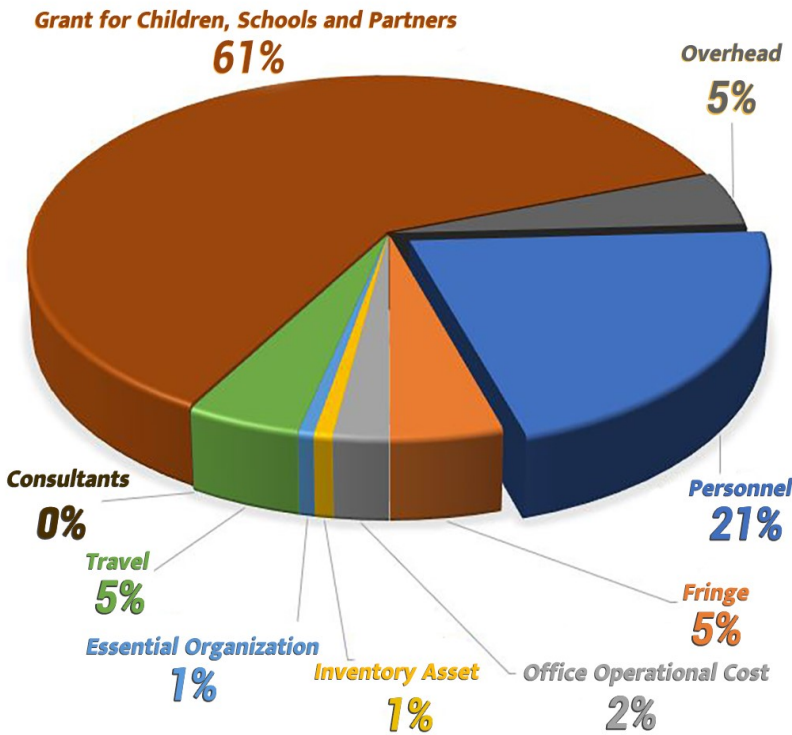

Revenue Streams in FY2019

Donors	Amount (USD)
Ministry of Education, Youth and Sport	1,829,016.90
Kinchan Stiftung	574,675.63
We World	379,010.45
Child Fund Cambodia	377,894.54
The Phoenix Foundation	144,938.89
The Gap Inc.	94,995.00
World Education	82,251.84
The Asia Foundation	69,722.59
Save the Children	57,142.04
The Oaktree Foundation	39,901.49
Franks Family Foundation	25,700.00
Research Triangle Institution	23,378.70
Lotus Outreach Society Canada	15,500.00
US. Embassy	14,745.45
VVOB Cambodia/EU	13,231.31
Classroom of Hope/Navitas	11,983.91
InsTEDD	6,701.80
New Revenue Received FY2019	3,760,790.54

A Note of Appreciation

Once again, on behalf of the children, teachers, parents, and those who benefit from our programs, KAPE would like to thank all donors for their support this year and in past years. Financial and in-kind support make it possible for KAPE to create and engage in meaningful services.

Thank you!

KAPE Management Team FY2019

Board of Directors



Senior Management Team (SMT)



KAPE Management Team Members *(In alphabetical order)*



*** *Note:* Thun Thean Obrum (TTO) is an autonomous social enterprise affiliated with KAPE.

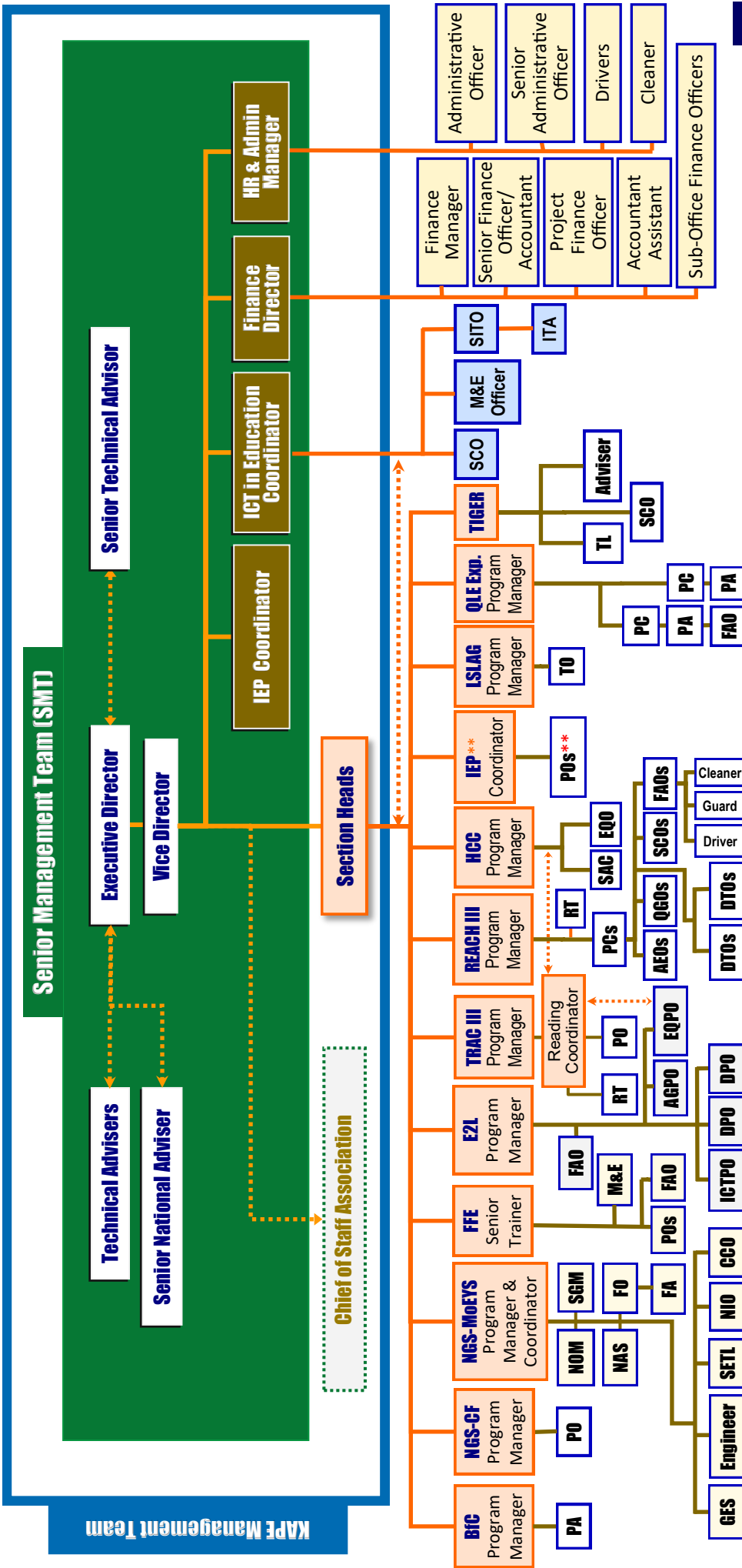

Section Heads

Two-way arrows = Relationships with Advisers, reading coordinator and ICT.
 Dashed Boxes = Autonomy. The Staff Association is a fully autonomous collective.
 POS** The IEP umbrella comprises the Kampuchean Young Leaders' Action (KYLA), STEM4WOMEN, ACCESS and Cambodian Tertiary Scholarship Program (CTSP). "POS" here represents all officers within IEP.
 *Please note that the organization levels below Section Heads are not intended for comparison to those of Finance and HR/Admin groups, which have been simplified to lists.

AEOS Access + Parent Engage't Officers	RTL Research Team Leader
AGPO Access & Governance PO	SCO Senior Communications Officer
AS Assistant	SA School Animators (2)
BIC Books for Cambodia	SAC School Access
CCO Career Counseling Officer	SCOS Senior Community Officers (CIA)
DPO District-based Program Officer	SEA Science Education Assistant
DTOS District Technical Officers	SETL Science Education Team Leader
EQO Educational Quality Officer	SGM School Governance Mentors (2)
E2L Easy2Learn	SITO Senior Informatic Technology Officer
	TIGER Teaching Improved Gender Equality and Responsiveness
	TL Team Leader
	TO Training Officer
	TRAC III Total Reading Approach for Children III

NAS NGS Adviser (ICT in Education)	NGS New Generation School	NGS** NGS in ICT Officer	NOM NGS Operations Manager	QOGS Quality and Governance Officers	PA Program Assistant	PC Primary Education Department/ Department of Curriculum Development	PO Program Officer	QLE EXP. Quality Learning Environment Expansion	REACH III Reinforcing Education Access with Community Health	RT Reading Trainer
--	-------------------------------------	------------------------------------	--------------------------------------	--	--------------------------------	---	------------------------------	---	--	------------------------------

EOPO Education Quality PO	FAO Finance-Admin Officer	FO Finance Officer	GES General Education Specialist	HCC Happy Cambodian Children Project	ICT in ES Information Communications in Education Specialist	ICTPO Inclusive Education Program	IEP Informatic Communications Technology in Education PO	ITA Informatic Technology Assistant	KLS Khmer Language Specialist	LSLAG Life Skills Learning for Adolescent Girl Project	M&E Monitoring & Evaluation Program Officer (MIS)	M&ES/RT Monitoring & Evaluation Specialist/Reading Trainer
-------------------------------------	-------------------------------------	------------------------------	--	--	--	---	--	---	---	--	---	--

NAS NGS Adviser (ICT in Education)	NGS New Generation School	NGS** NGS in ICT Officer	NOM NGS Operations Manager	QOGS Quality and Governance Officers	PA Program Assistant	PC Primary Education Department/ Department of Curriculum Development	PO Program Officer	QLE EXP. Quality Learning Environment Expansion	REACH III Reinforcing Education Access with Community Health	RT Reading Trainer
--	-------------------------------------	------------------------------------	--------------------------------------	--	--------------------------------	---	------------------------------	---	--	------------------------------

PC Primary Education Department/ Department of Curriculum Development	PA Program Assistant	FAO Finance-Admin Officer	PA Program Assistant	FAO Finance-Admin Officer	PA Program Assistant
---	--------------------------------	-------------------------------------	--------------------------------	-------------------------------------	--------------------------------